

# DS017914

Ultra-Small size LoRaWAN module RHF0M003

V1.2

## Document information

Info	Content
<b>Keywords</b>	<i>RisingHF, LoRaWAN, Module, Ultra-Small size, AT command</i>
<b>Abstract</b>	This document is a datasheet of RHF0M003 LoRaWAN module.

## Content

Content.....	2
Figures .....	3
Tables.....	4
1 General description.....	1
1.1 Simplified Block Diagram.....	1
1.2 Pin description.....	1
2 Electrical Characteristics.....	2
2.1 Absolute Maximum Ratings.....	2
2.2 Operating Range.....	2
2.3 Module Specifications .....	3
3 Typical Performance Characteristics Measurement.....	4
3.1 RHF0M003-LF20 measurement.....	4
3.2 RHF0M003-HF20 measurement .....	7
4 Application Information .....	9
4.1 Package Information .....	9
4.2 Internal connection .....	10
4.3 Interface of Module.....	11
4.4 Reference design with RHF0M003 Module .....	11
5 Application in LoRaWAN.....	12
5.1 LoRaWAN .....	12
5.2 LoRaWAN sensor with RHF0M003 .....	12
6 Ordering information .....	13
Revision.....	14

**Figures**

Figure 1-1 RHF0M003 Module Outline ..... 5

Figure 1-1 Block Diagram of RHF0M003 ..... 1

Figure 1-2 schematic of RHF0M003 ..... 1

Figure 3-1 TXOP vs Supply voltage ..... 4

Figure 3-2 Sensitivity (SF10/SF12,125kHz) vs Supply voltage..... 4

Figure 3-3 Frequency Tolerance vs Temperature ..... 5

Figure 3-4 TXOP vs Temperature ..... 5

Figure 3-5 Sensitivity (SF12,125kHz) vs temperature ..... 5

Figure 3-6 Harmonics measurement @Frf=434MHz, TXOP=20dBm ..... 6

Figure 3-7 Harmonics measurement @Frf=470MHz, TXOP=20dBm ..... 6

Figure 3-8 TXOP vs Supply voltage ..... 7

Figure 3-9 Sensitivity (SF10/SF12,125kHz) vs Supply voltage..... 7

Figure 3-10 Frequency Tolerance vs Temperature ..... 8

Figure 3-11 TXOP vs Temperature ..... 8

Figure 3-12 Sensitivity (SF12,125kHz) vs temperature ..... 8

Figure 3-13 Harmonics measurement @Frf=868MHz, TXOP=20dBm ..... 9

Figure 3-14 Harmonics measurement @Frf=915MHz, TXOP=20dBm ..... 9

Figure 4-1 package outline drawing ..... 10

Figure 4-2 Recommended land pattern..... 10

Figure 4-3 Reference design with RHF0M003 ..... 11

Figure 5-1 LoRaWAN sensor with RHF0M003..... 12

## Tables

Table 1-1	pin description.....	2
Table 2-1	Absolute Maximum Ratings .....	2
Table 2-2	Operating Range.....	2
Table 2-3	Module Specifications .....	3
Table 4-1	Internal IO connection between MCU(STM32L07x) and Radio(SX127x) .....	10
Table 4-2	RF control logic.....	11
Table 6-1	Ordering information .....	13

## RHF0M003 ultra-small size LoRaWAN Module

### Low Power ultra-small Size LoRaWAN Module

#### General description

RHF0M003 LoRaWAN Module is a low cost, low power and ultra-small size module, embedded with Semtech's LoRa propriety chip SX127x and ST's ultra-low power MCU STM32L07x. The module designed by RisingHF (Shenzhen) is targeted to application in sensor network and others IOT devices powered by battery which need low power consumption to extend the battery lifetime.

This datasheet will give some details of description of the module, including HW design info, performance validation, and application information.

#### Applications

The RHF0M003 LoRaWAN Module is designed for end device which need long range and low power consumption, such as metering, sensor network, and others IOT application.

#### Key features

- ◆ Low power consumption: 1.45uA sleep current in WOR mode
- ◆ Ultra-small size: 14mm X 20mm

18 pins SMT package

- ◆ High performance:  
**RHF0M003-LF20:**  
TXOP=20dBm@434MHz/470MHz  
**RHF0M003-HF20:**  
TXOP=20dBm@868MHz/915MHz  
160dB link budget, suitable for long range
- ◆ User-friendly interface  
USART;  
I2C;  
USB;  
ADC;  
GPIOs
- ◆ LoRaWAN embedded with AT command:
- ◆ Support global LoRaWAN protocol  
EU868;  
US915 and US915 Hybrid;  
CN779;  
EU433;  
AU915;  
CN470 and CN470 Prequel;  
AS923;  
KR920;  
IN865;

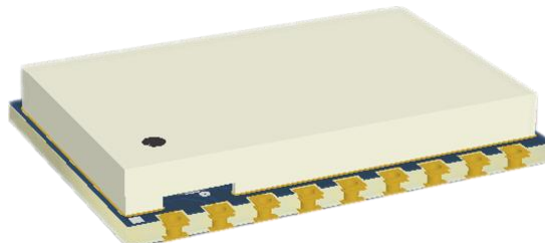

Figure 1-1 RHF0M003 Module Outline

This product datasheet contains a detailed description of the RHF0M003 performance and functionality. Please consult with RisingHF for the latest updates, Firmware or errata.

## 1 General description

The RHF0M003 incorporates SX127x and STM32L07x, and is well suited for node in the networking of IOT.

Based on the powerful functions and performance of SX127x, the RHF0M003 could operate in both (G)FSK and LoRa. In LoRa mode, BW with 62.5kHz, 125kHz, 250kHz and 500kHz could be used. And with the STM32L07x MCU, the module could provide SPI, UART, I2C, ADC and some other GPIOs for customer to extend their application. Two wire interface (SWIM) is suggested to be used for programming.

RHF0M003 include two part numbers, RHF0M003-LF20 and RHF0M003-HF20. RHF0M003-LF20 support 20dBm@LF band (434MHz/470MHz), and RHF0M003-HF20 support 20dBm@HF band (868MHz/915MHz).

### 1.1 Simplified Block Diagram

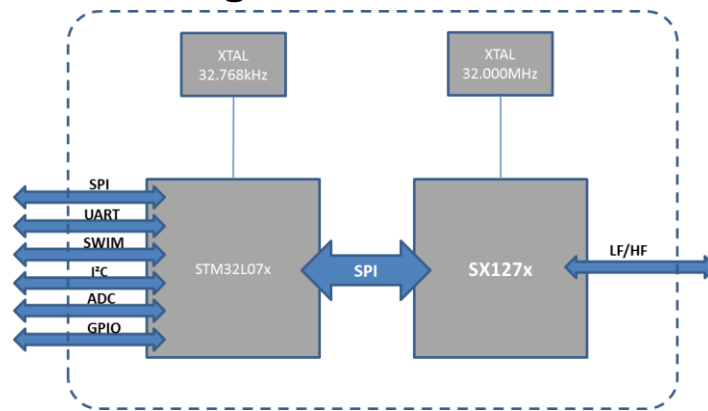

Figure 1-1 Block Diagram of RHF0M003

### 1.2 Pin description

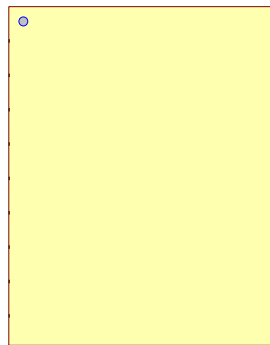

Figure 1-2 schematic of RHF0M003

**Table 1-1 pin description**

Number	Name	Type	Description
1	GND	-	Ground
2	RFIO_HF	-	RF input/output
3	GND	-	Ground
4	BOOT0	I	BOOT0 for MCU (connected to GND via 10k internal)
5	I2C_SDA	I/O	SCL of I2C from MCU; or GPIO from MCU, PB7
6	I2C_SCL	I/O	SDA of I2C from MCU; or GPIO from MCU, PB6
7	LPUART_TX_ADC	I/O	Low power USART_TX from MCU; or GPIO from MCU, PA2
8	LPUART_RX_ADC	I/O	Low power USART_RX from MCU; or GPIO from MCU, PA3
9	GND	-	Ground
10	VCC	-	Supply voltage for the module
11	GND	-	Ground
12	PA9/USART1_TX	I/O	USART1_TX from MCU; or GPIO from MCU, PA9
13	PA10/USART1_RX	I/O	USART1_RX from MCU; or GPIO from MCU, PA10
14	PA11/USB_DM	I/O	GPIO from MCU, PA11
15	PA12/USB_DP	I/O	GPIO from MCU, PA12
16	SWDIO	I/O	SWDIO of SWIM for program download
17	SWCLK	I/O	SWCLK of SWIM for program download
18	NRST	I	Reset trigger input for MCU

## 2 Electrical Characteristics

### 2.1 Absolute Maximum Ratings

As stated that the values listed below may cause permanent device failure. Exposure to absolute maximum ratings for extended periods may affect device reliability.

**Table 2-1 Absolute Maximum Ratings**

Item	Description	min	max	unit
VCCmr	Supply voltage	-0.3	+3.9	V
Tmr	Temperature	-55	+115	°C
Pmr	RF input level	-	+10	dBm

### 2.2 Operating Range

**Table 2-2 Operating Range**

Item	Description	min	max	unit
VCCop	Supply voltage	+1.8	+3.6	V
Top	Temperature	-40	+85	°C

Pop	RF input level	-	+10	dBm
-----	----------------	---	-----	-----

## 2.3 Module Specifications

Table 2-3 Module Specifications

ITEMs	Parameter	Specifications	Unit
<b>Structure</b>	Size	14(W) X 20(L) X 2.6(H)	mm
	Package	18 pins, SMT	
<b>Electrical Characteristics</b>	power supply	3.3V type	V
	Sleep current	1.45uA (WDT off)	uA
	Operation current (Transmitter+MCU)	120mA @20dBm in 434MHz/470MHz type	mA
		130mA @20dBm in 868MHz/915MHz type	mA
	Operation current (Receiver+MCU)	21mA @BW125kHz, 434MHz/470MHz type	mA
		21mA @BW125kHz, 868MHz/915MHz type	mA
	Output power	20dBm max @434MHz/470MHz	dBm
		20dBm max @868MHz/915MHz	dBm
	Sensitivity	-139dBm @SF12, BW125kHz, 434MHz/470MHz	dBm
		-137dBm @SF12, BW125kHz, 868MHz/915MHz	dBm
Harmonics (LF Output)	<-42dBm below 1GHz	dBm	
	<-35dBm above 1GHz	dBm	
Harmonics (HF output)	<-40dBm above 1GHz	dBm	
<b>Interface</b>	RFIO	RF port	
	USART	2 group of USART, include 2pins	
	USB	1 group of USB, include 2 pins	
	I2C	1 group of I2C, include 2 pins	
	ADC	2 ADC Input, include 2 pins, reuse with LPUART port	
	NRST	Manual reset pin input	



## 3 Typical Performance Characteristics Measurement

### 3.1 RHF0M003-LF20 measurement

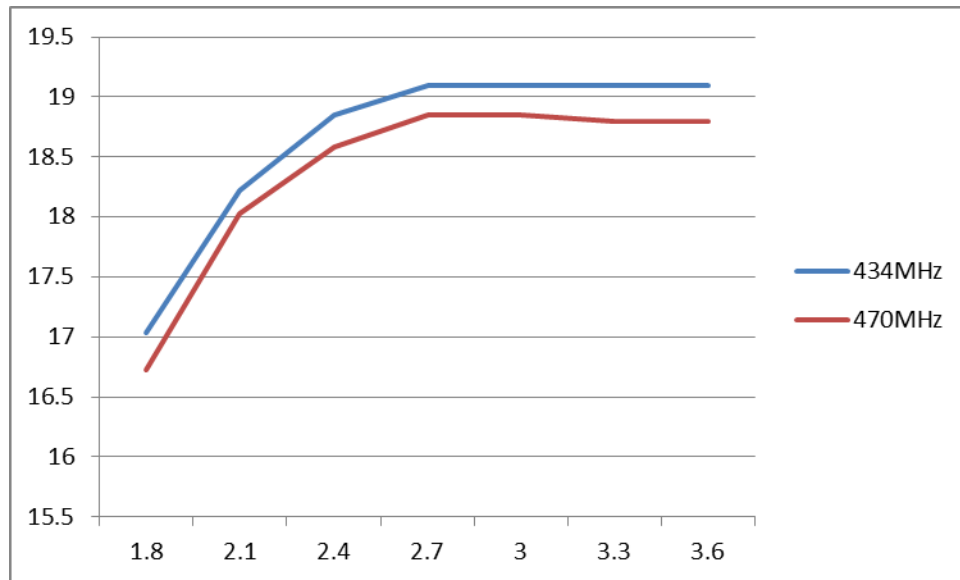

Figure 3-1 TXOP vs Supply voltage

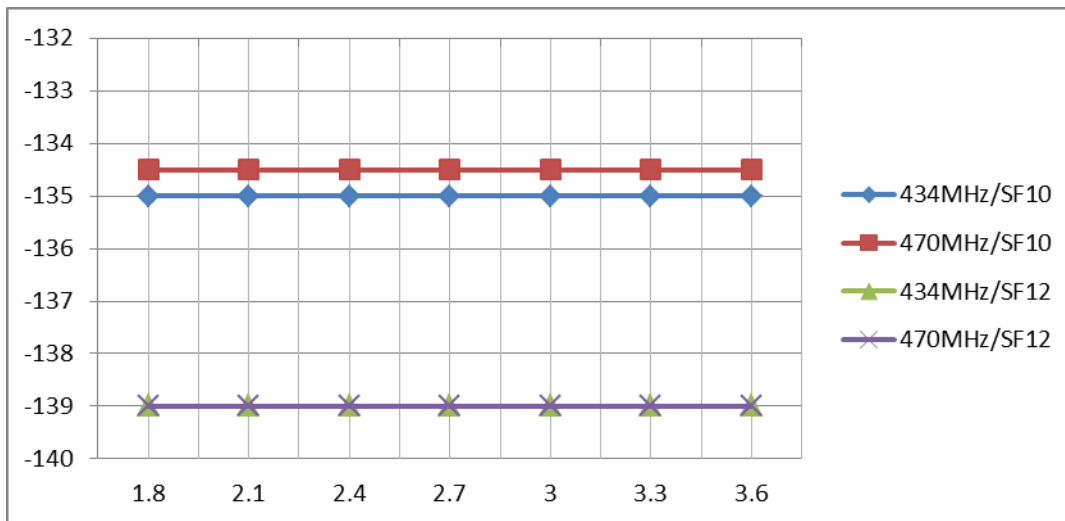

Figure 3-2 Sensitivity (SF10/SF12,125kHz) vs Supply voltage

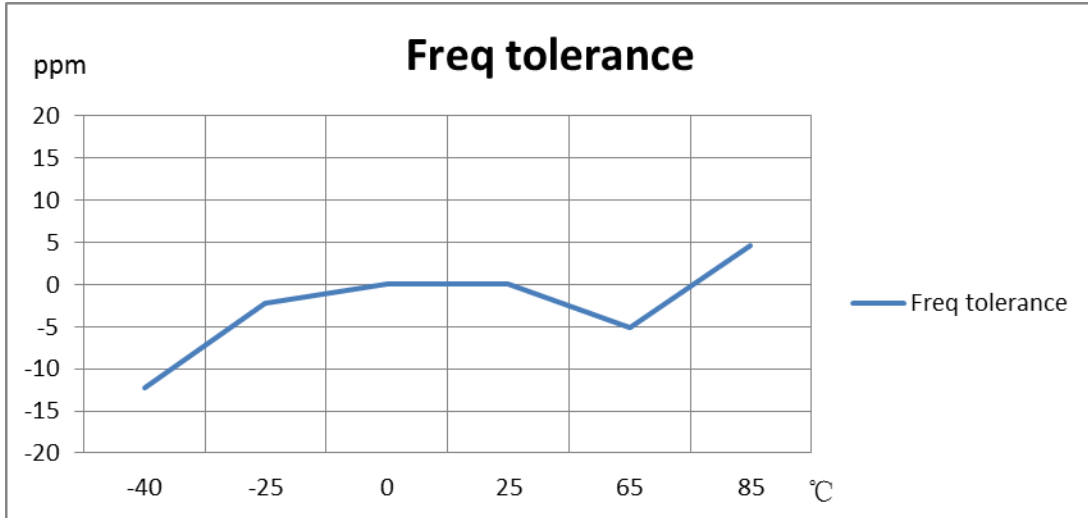

Figure 3-3 Frequency Tolerance vs Temperature

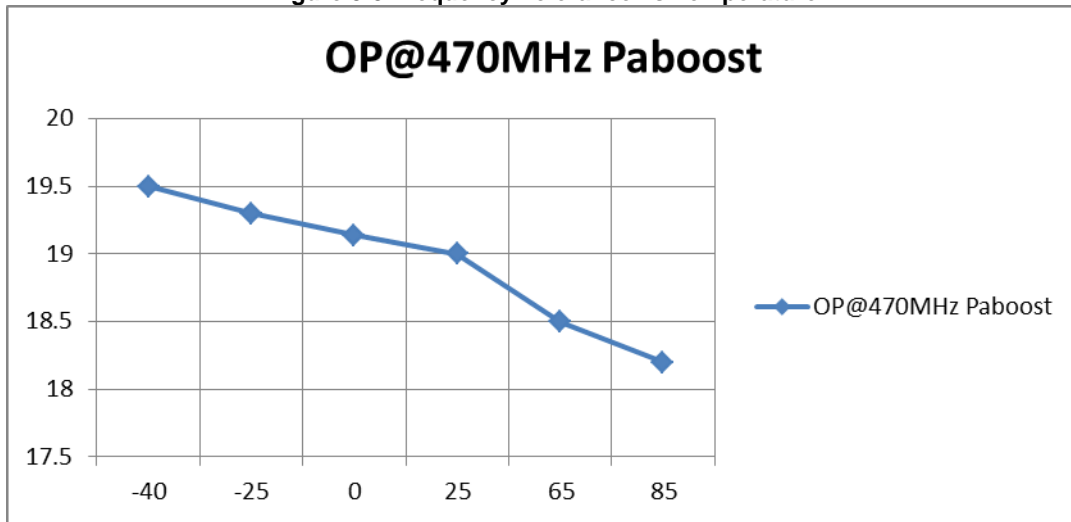

Figure 3-4 TXOP vs Temperature

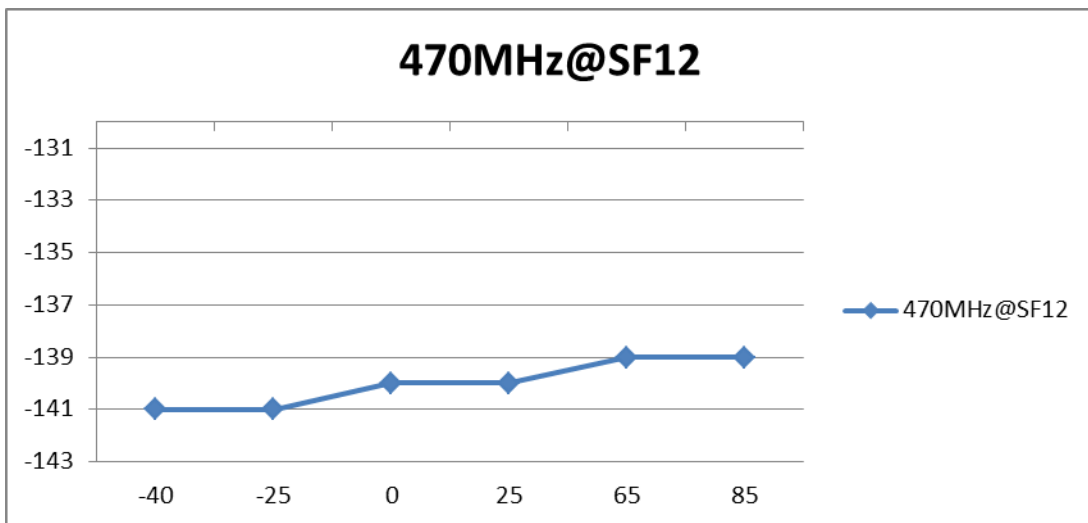

Figure 3-5 Sensitivity (SF12,125kHz) vs temperature

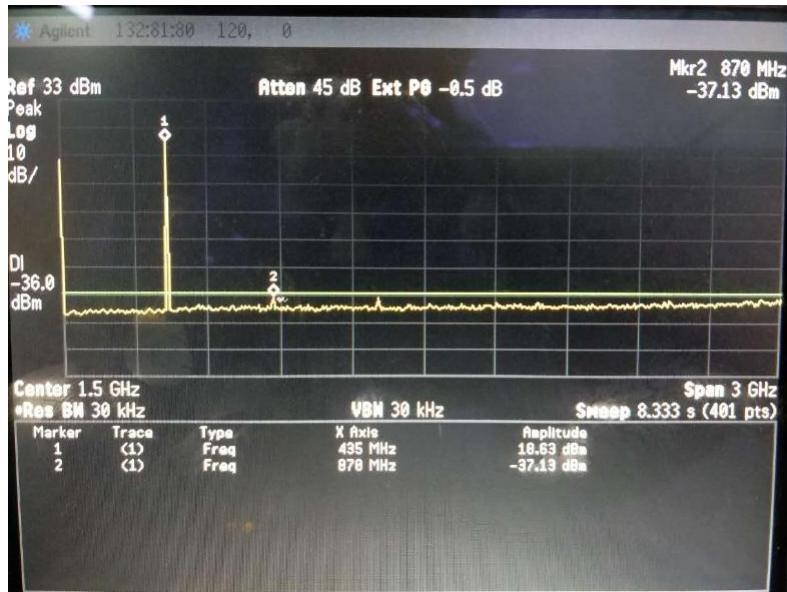

Figure 3-6 Harmonics measurement @Frf=434MHz, TXOP=20dBm

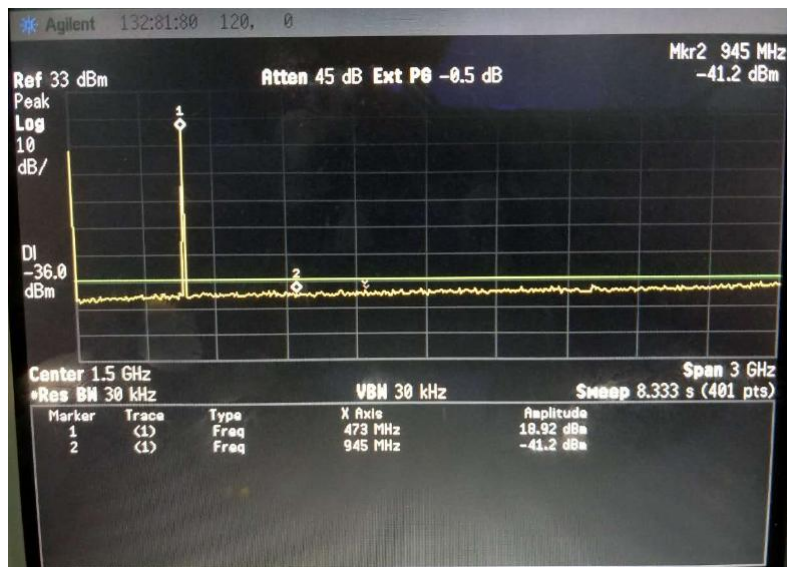

Figure 3-7 Harmonics measurement @Frf=470MHz, TXOP=20dBm

## 3.2 RHF0M003-HF20 measurement

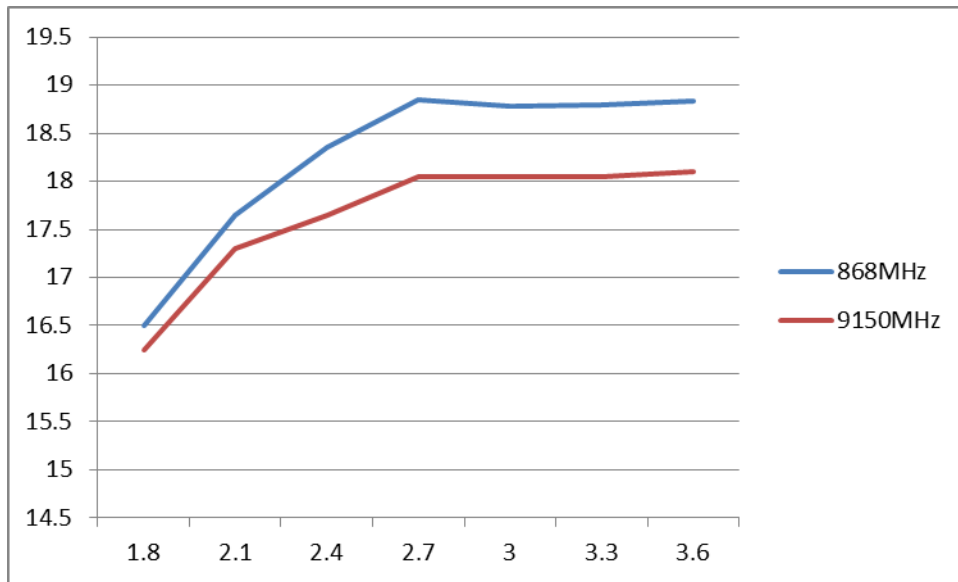

Figure 3-8 TXOP vs Supply voltage

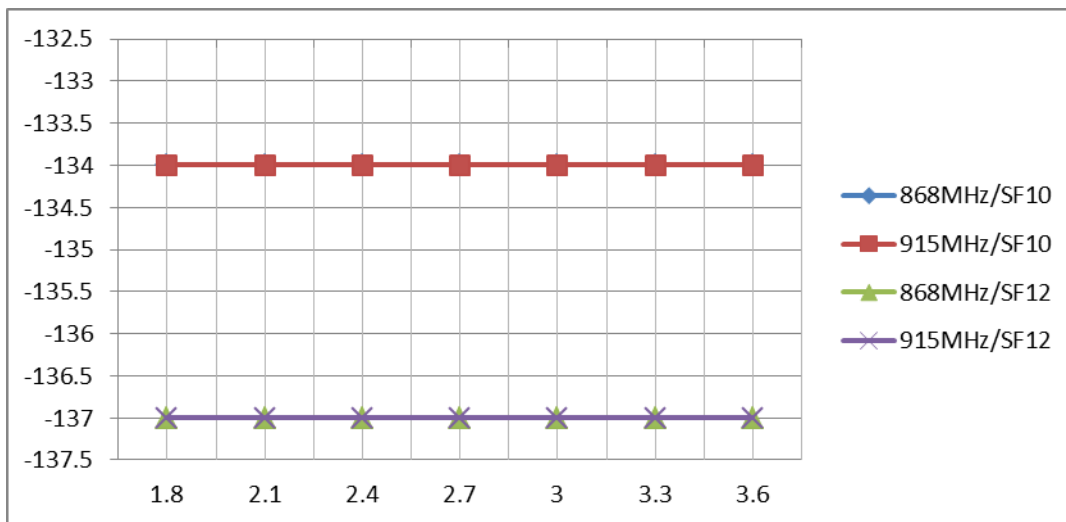

Figure 3-9 Sensitivity (SF10/SF12,125kHz) vs Supply voltage

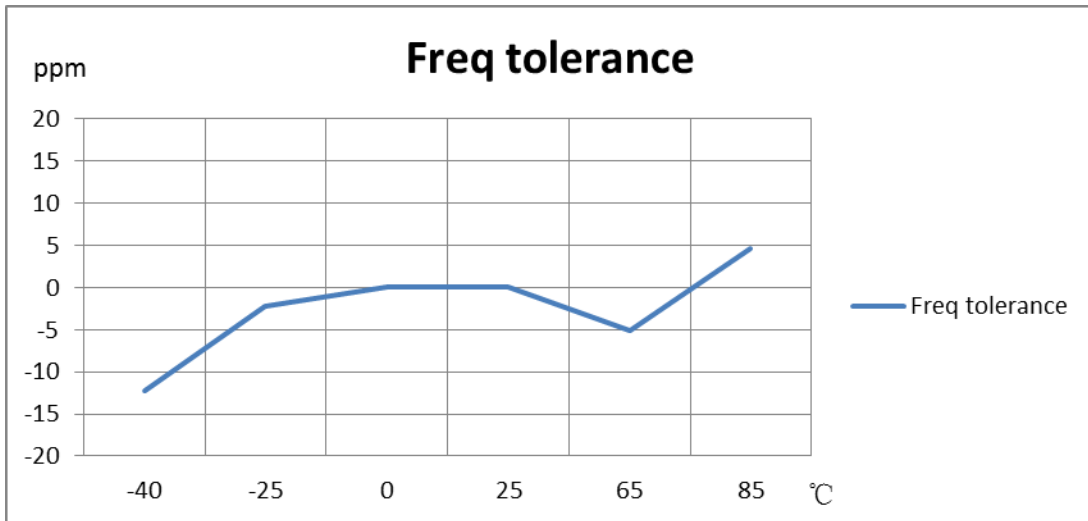

Figure 3-10 Frequency Tolerance vs Temperature

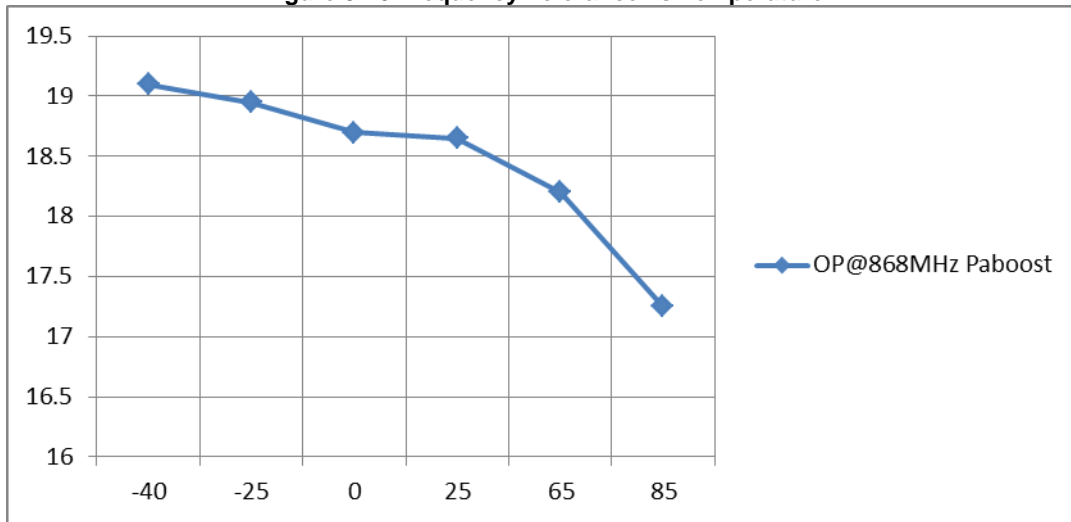

Figure 3-11 TXOP vs Temperature

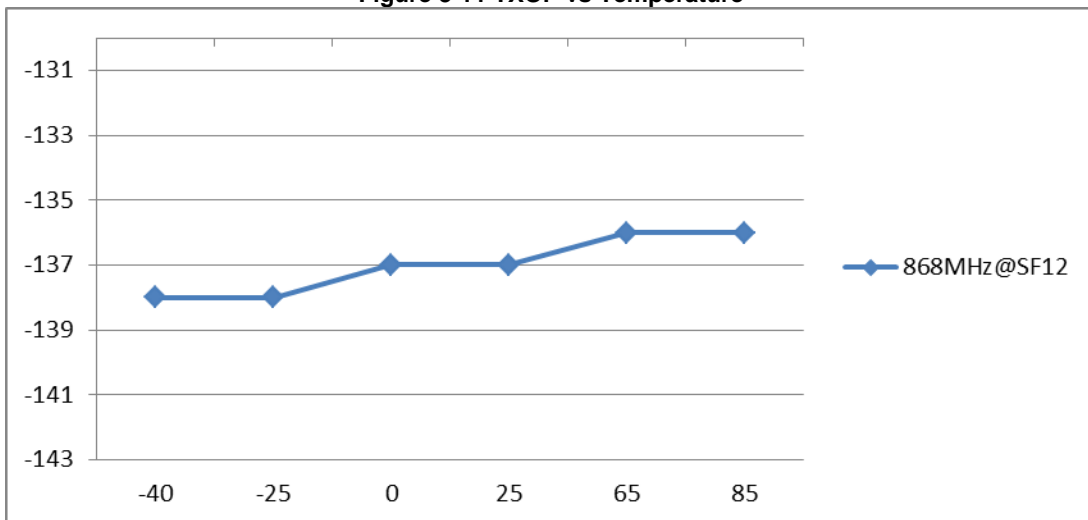

Figure 3-12 Sensitivity (SF12,125kHz) vs temperature

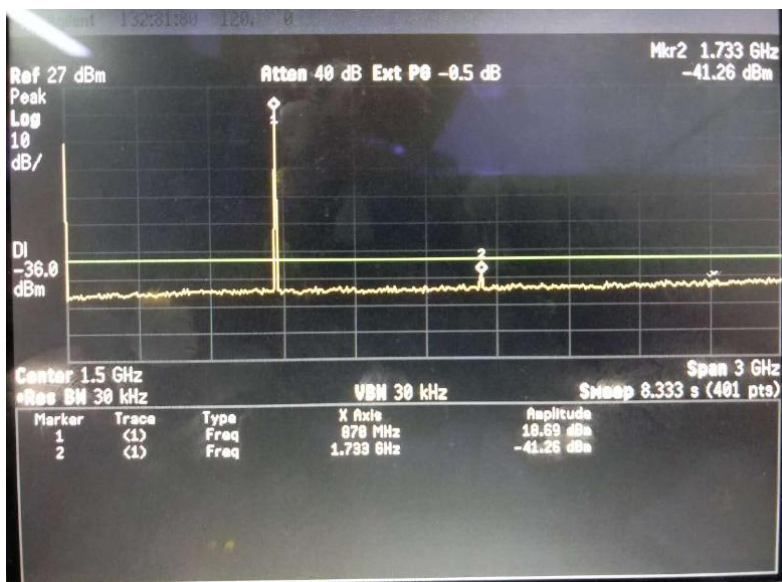

Figure 3-13 Harmonics measurement @Frf=868MHz, TXOP=20dBm

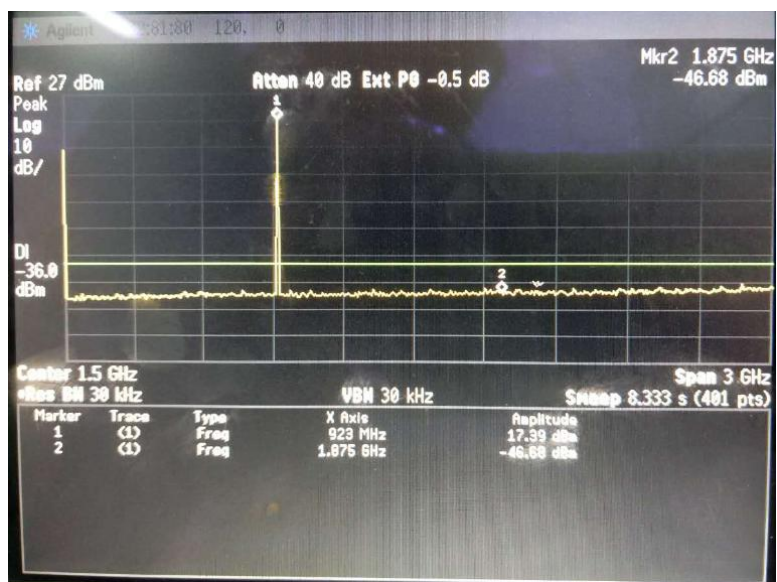

Figure 3-14 Harmonics measurement @Frf=915MHz, TXOP=20dBm

## 4 Application Information

### 4.1 Package Information

Unless other specified, the dimension tolerance is  $\pm 0.1$ mm.

The RHF0M003 is available in a 18-lead SMD package as shown below:

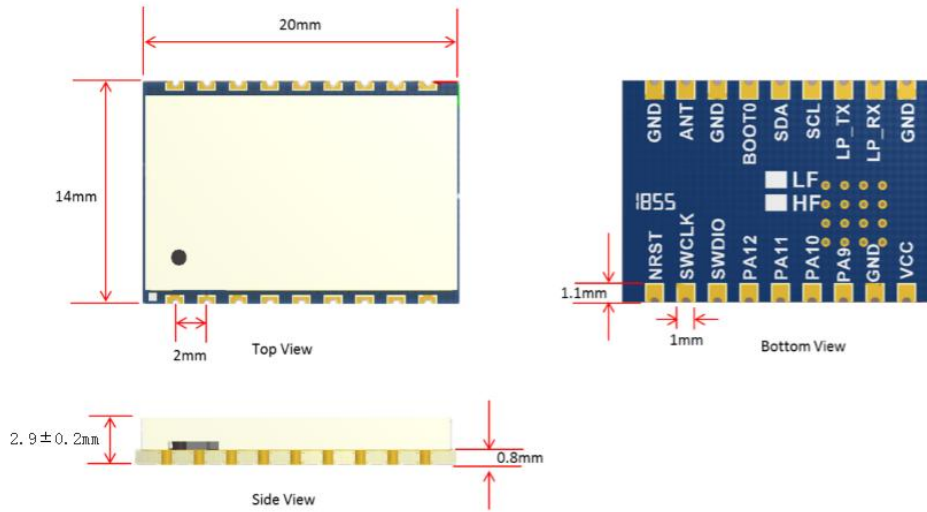

Figure 4-1 package outline drawing

Figure 4-2 show the recommended land pattern for layout.

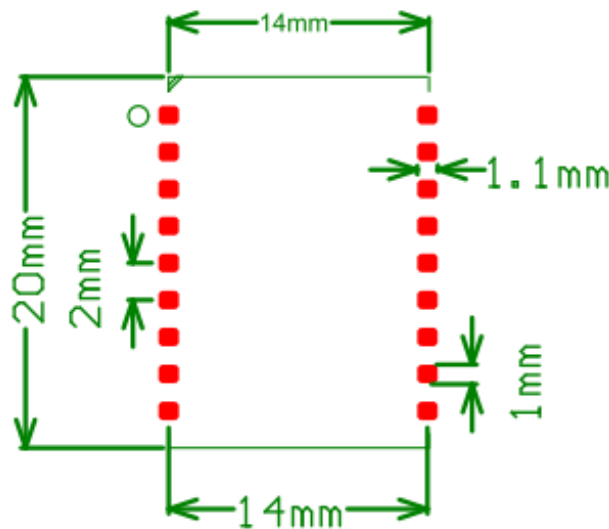

Figure 4-2 Recommended land pattern

## 4.2 Internal connection

Table 4-1 and Table 4-2 provides the internal connection which could help customers who would design their own firmware instead of using RisingHF AT command mode.

Table 4-1 Internal IO connection between MCU(STM32L07x) and Radio(SX127x)

Chip	SX127x		STM32L07x	
Item	Pin Num	Description	Pin Num	Description
IO connection Between SX127x and STM32L07x	Pin7	NRESET_SX	Pin6	PA0
	Pin8	DI00_SX	Pin26	PB4
	Pin9	DI01_SX	Pin18	PA8
	Pin10	DI02_SX	Pin15	PB1

Pin11	DI03_SX	Pin14	PB0
Pin12	DI04_SX	NC	NC
Pin13	DI05_SX	Pin7	PA1
Pin16	SCK_SX	Pin11	PA5
Pin17	MISO_SX	Pin12	PA6
Pin18	MOSI_SX	Pin13	PA7
Pin19	NSS_SX	Pin10	PA4

**Table 4-2 RF control logic**

RF Switch Control	Pin Num/MCU	Description	Definition	Logic	Status
	Pin27	PB5	Switch_CTL	0	TX ON
	Pin27	PB5	Switch_CTL	1	RX ON
	Pin27	PB5	Switch_CTL	0	Sleep

### 4.3 Interface of Module

Except that several essential GPIOs and one group of SPI would be used for internal transceiver control, all others GPIOs and interface of the MCU would be connected to external pins of the module, which includes USART, I2C, USB, ADC and so on.

### 4.4 Reference design with RHF0M003 Module

RHF0M003 is integrated with LoRaWAN protocol and AT command. LoRaWAN node design with RHF0M003 is very simple. Just connect the USART and NRST to their host MCU and send AT command.

Pin7 of the module could be used to show status of the modem. The LED1 would blink if uplink or downlink operates. Let it float if not used.

Pin8 of the module could be used to trigger the bootloader mode. It's useful to upgrade the FW of the AT command. Let it float if not used.

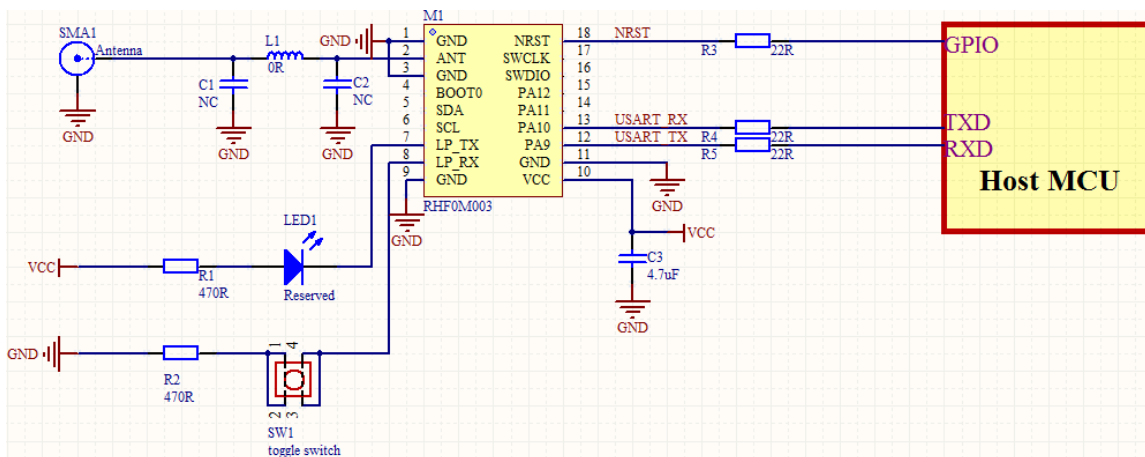

**Figure 4-3 Reference design with RHF0M003**



## 5 Application in LoRaWAN

### 5.1 LoRaWAN

LoRaWAN networks typically are laid out in a star-of-stars topology in which gateways relay messages between end-devices and a central network server at the backend. Gateways are connected to the network server via standard IP connections while end devices use single-hop LoRa™ or FSK communication to one or many gateways. All communication is generally bi-directional, although uplink communication from an end device to the network server is expected to be the predominant traffic. Communication between end-devices and gateways is spread out on different frequency channels and data rates. The selection of the data rate is a trade-off between communication range and message duration, communications with different data rates do not interfere with each other. LoRa data rates range from 0.3 kbps to 50 kbps, with different Band Width and Spreading Factor. To maximize both battery life of the end-devices and overall network capacity, the LoRa network infrastructure can manage the data rate and RF output for each end-device individually by means of an adaptive data rate (ADR) scheme.

End-devices may transmit on any channel available at any time, using any available data rate, as long as the following rules are respected:

- 1) The end-device changes channel in a pseudo-random fashion for every transmission. The resulting frequency diversity makes the system more robust to interferences.
- 2) The end-device respects the maximum transmit duty cycle relative to the sub-band used and local regulations.

The RHF0M003 Module incorporates Semtech’s LoRa Chip SX1276 and ST’s ultra-low power MCU. With only 1.45uA sleep current in WOR mode, the module is really very suitable for LoRaWAN application.

### 5.2 LoRaWAN sensor with RHF0M003

RHF0M003 is AT command LoRaWAN modem, which is LoRaWAN protocol embedded. Customer just need use a simple host mcu with application to control the modem via UART that a LoRaWAN sensor could be designed easily. This will help customer to promote their sensor devices to market quickly.

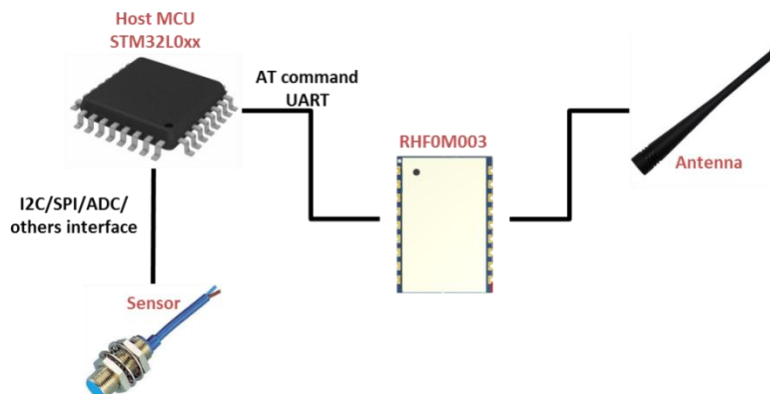

Figure 5-1 LoRaWAN sensor with RHF0M003

### 6 Ordering information

---

Technical Support: [Support@RisingHF.com](mailto:Support@RisingHF.com)

Business:

China: [Salescn@RisingHF.com](mailto:Salescn@RisingHF.com)

Others: [Salesww@RisingHF.com](mailto:Salesww@RisingHF.com)

Table 6-1 Ordering information

Part Number	MCU	TX Power (dBm)	AT Modem
RHF0M003-LF20	ROM 192KB / RAM 20KB	19@LF (434/470MHz)	Yes
RHF0M003-HF20	ROM 192KB / RAM 20KB	19@HF (868/915MHz)	Yes

## Revision

V1.2 2019-1-22

+ Update footprint

V1.1 2017-09-16

+ Update with measurement results

V1.0 2017-08-14

+ Draft Creation

### **Please Read Carefully:**

Information in this document is provided solely in connection with RisingHF products. RisingHF reserve the right to make changes, corrections, modifications or improvements, to this document, and the products and services described herein at any time, without notice.

All RisingHF products are sold pursuant to RisingHF's terms and conditions of sale.

Purchasers are solely responsible for the choice, selection and use of the RisingHF products and services described herein, and RisingHF assumes no liability whatsoever relating to the choice, selection or use of the RisingHF products and services described herein.

No license, express or implied, by estoppel or otherwise, to any intellectual property rights is granted under this document. If any part of this document refers to any third party products or services it shall not be deemed a license grant by RisingHF for the use of such third party products or services, or any intellectual property contained therein or considered as a warranty covering the use in any manner whatsoever of such third party products or services or any intellectual property contained therein.

UNLESS OTHERWISE SET FORTH IN RISINGHF'S TERMS AND CONDITIONS OF SALE RisingHF DISCLAIMS ANY EXPRESS OR IMPLIED WARRANTY WITH RESPECT TO THE USE AND/OR SALE OF RisingHF PRODUCTS INCLUDING WITHOUT LIMITATION IMPLIED WARRANTIES OF MERCHANTABILITY, FITNESS FOR A PARTICULAR PURPOSE (AND THEIR EQUIVALENTS UNDER THE LAWS OF ANY JURISDICTION), OR INFRINGEMENT OF ANY PATENT, COPYRIGHT OR OTHER INTELLECTUAL PROPERTY RIGHT.

RISINGHF PRODUCTS ARE NOT DESIGNED OR AUTHORIZED FOR USE IN: (A) SAFETY CRITICAL APPLICATIONS SUCH AS LIFE SUPPORTING, ACTIVE IMPLANTED DEVICES OR SYSTEMS WITH PRODUCT FUNCTIONAL SAFETY REQUIREMENTS; (B) AERONAUTIC APPLICATIONS; (C) AUTOMOTIVE APPLICATIONS OR ENVIRONMENTS, AND/OR (D) AEROSPACE APPLICATIONS OR ENVIRONMENTS. WHERE RISINGHF PRODUCTS ARE NOT DESIGNED FOR SUCH USE, THE PURCHASER SHALL USE PRODUCTS AT PURCHASER'S SOLE RISK, EVEN IF RISINGHF HAS BEEN INFORMED IN WRITING OF SUCH USAGE, UNLESS A PRODUCT IS EXPRESSLY DESIGNATED BY RISINGHF AS BEING INTENDED FOR "AUTOMOTIVE, AUTOMOTIVE SAFETY OR MEDICAL" INDUSTRY DOMAINS ACCORDING TO RISINGHF PRODUCT DESIGN SPECIFICATIONS. PRODUCTS FORMALLY ESCC, QML OR JAN QUALIFIED ARE DEEMED SUITABLE FOR USE IN AEROSPACE BY THE CORRESPONDING GOVERNMENTAL AGENCY.

Resale of RisingHF products with provisions different from the statements and/or technical features set forth in this document shall immediately void any warranty granted by RisingHF for the RisingHF product or service described herein and shall not create or extend in any manner whatsoever, any liability of RisingHF.

RisingHF and the RisingHF logo are trademarks or registered trademarks of RisingHF in various countries.

Information in this document supersedes and replaces all information previously supplied.

The RisingHF logo is a registered trademark of RisingHF. All other names are the property of their respective owners.

© 2015 RISINGHF - All rights reserved

<http://www.risinghf.com>